

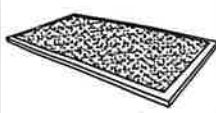







A	B	C	D	E	F	G	H	I	J
				 M6*15					 M8*35
4PCS	1PC	1PC	1PC	18PCS	2PCS See the combination 1.	4PCS	These spare parts need to purchase separately.		



There are quite many possibilities to build the sofa according to your specified request, here we would like to show you how to build the sofa in most common combinations as below;

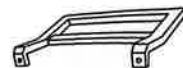
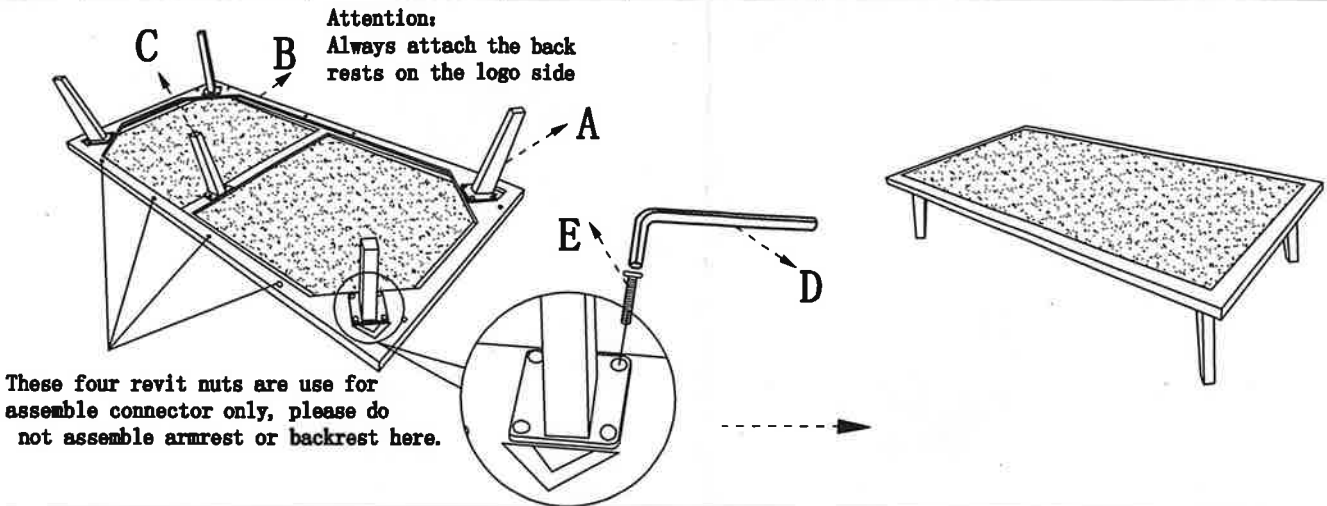